

LHF46-20
SCALE: 1/2" = 1'-0"
WEIGHT: 68#

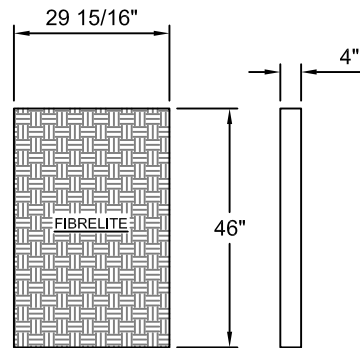

LHF46-30
SCALE: 1/2" = 1'-0"
WEIGHT: 84#

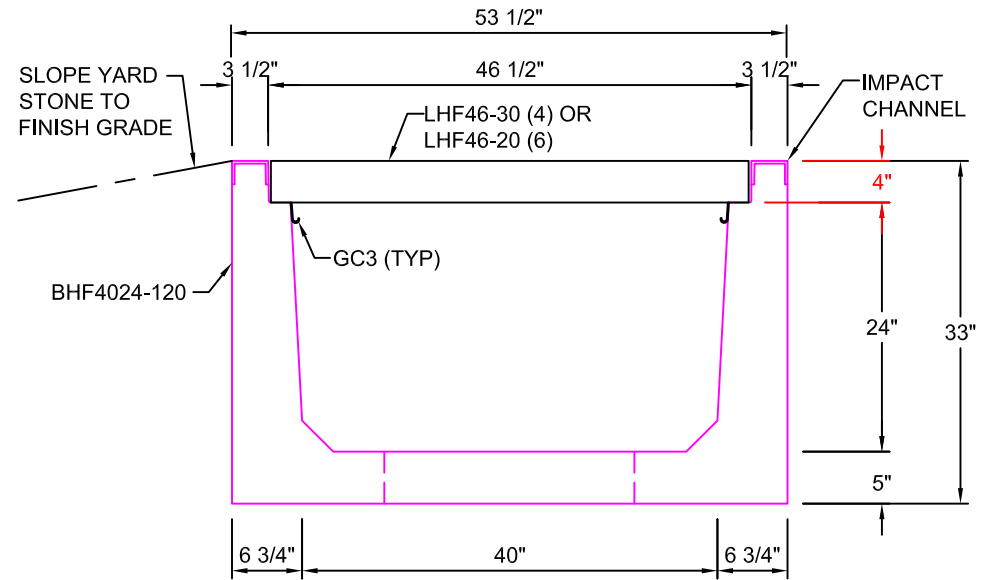

TYPICAL ROAD CROSSING SECTION WITH FIBRELITE LID
40"W x 24"D
SCALE: 1"=1'-0"

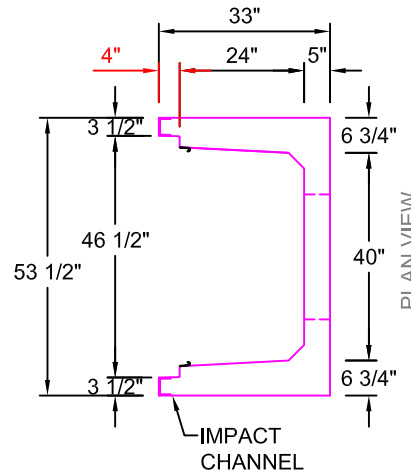
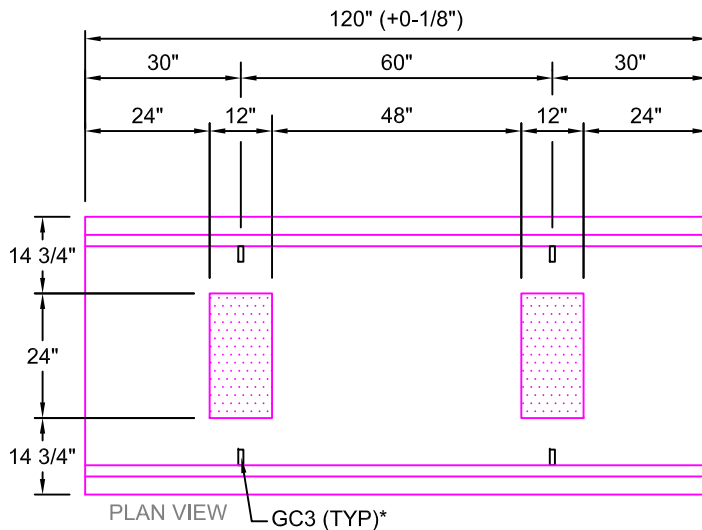

BHF4024-120
SCALE: 1/2" = 1'-0"
WEIGHT: 5999#

*GC3 (GROUND CLIPS) OPTIONAL

AASHTO HS20 DESIGN
(32,000 LBS / AXLE)

Trenwa Inc.	
1419 ALEXANDRIA PIKE FORT THOMAS, KY 41075 859-781-0831	
TYPICAL ROAD CROSSING BASE, FIBRELITE LID & SECTION FOR 40" WIDE x 24" DEEP TRENCH	
Date: 1/27/17	Dwg. No. BHF4024-120