

Secondary contained remote fill sump. 583mm dia. x 635mm deep solid base sump with a sealed secondary spill container and integrated drainback system. 450mm dia flat sealed cover and frame. Includes PSB-90-PS 90mm dia. spill tray fill riser sealkit and grounding cable sealkit.

For reference purposes only. This drawing is not a specification. Order against product code only. To enable continuous improvement of our products, the designs and specifications are subject to change without notice.

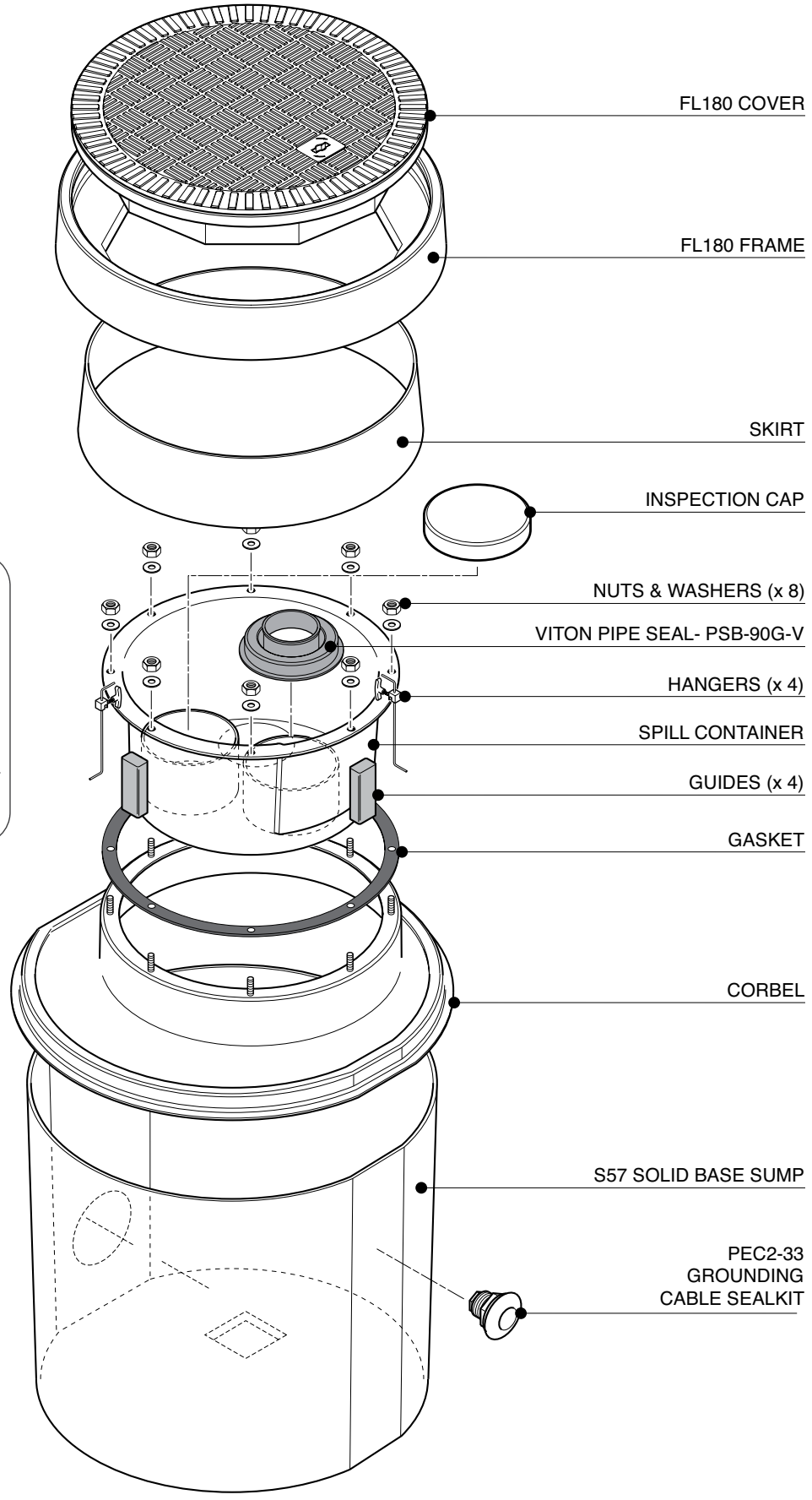

Secondary contained remote fill sump. 583mm dia. x 635mm deep solid base sump with a sealed secondary spill container and integrated drainback system. 450mm dia flat sealed cover and frame. Includes PSB-90-PS 90mm dia. spill tray fill riser sealkit and grounding cable sealkit.

For reference purposes only. This drawing is not a specification. Order against product code only. To enable continuous improvement of our products, the designs and specifications are subject to change without notice.



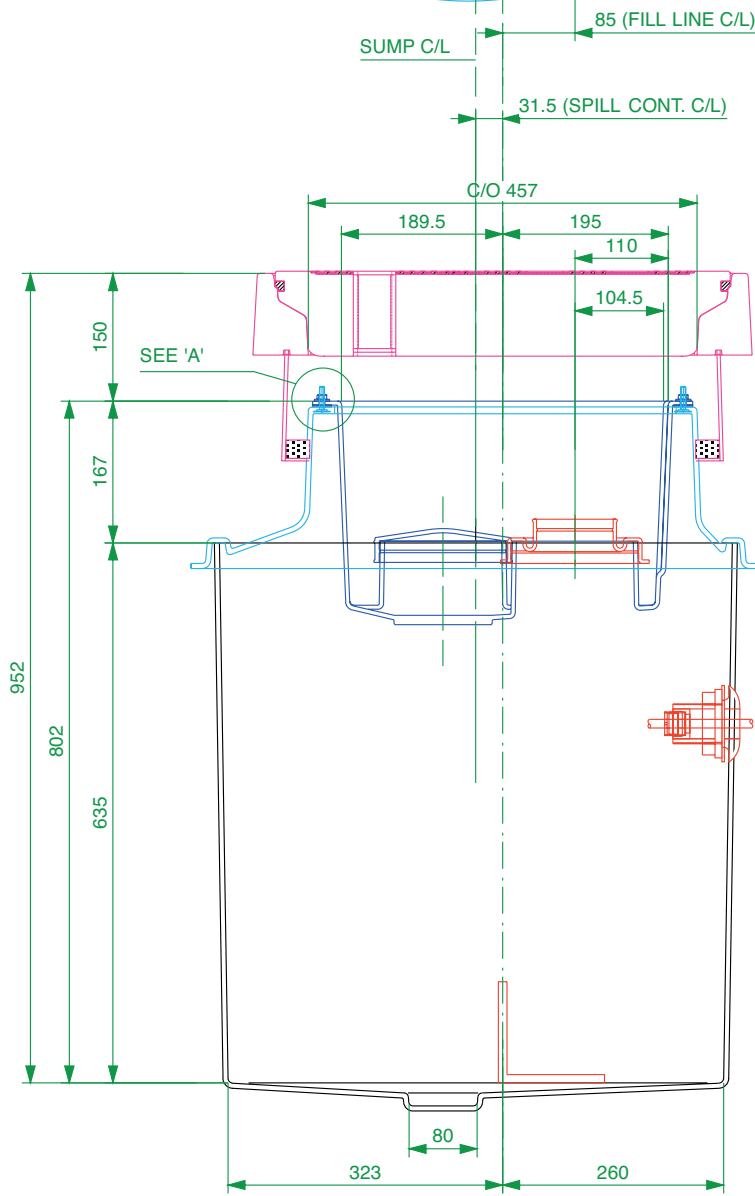
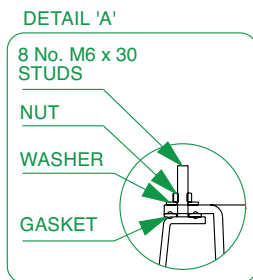
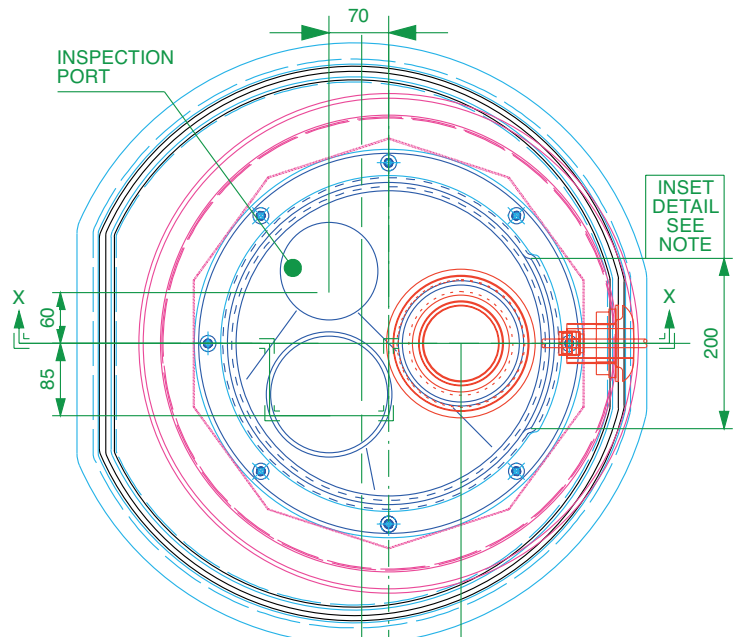

Spill Containment Capacity = 22 Litres

Secondary contained remote fill sump. 583mm dia. x 635mm deep solid base sump with a sealed secondary spill container and integrated drainback system. 450mm dia flat sealed cover and frame. Includes PSB-90-PS 90mm dia. spill tray fill riser sealkit and grounding cable sealkit.

For reference purposes only. This drawing is not a specification. Order against product code only. To enable continuous improvement of our products, the designs and specifications are subject to change without notice.

FIBRELITE 
 PART OF OPW A DOVER COMPANY

VERY IMPORTANT
 OUTER EDGE "A" OF FRAME SET 5 - 10MM
 ABOVE GENERAL FORECOURT AREA WITH
 CONCRETE RAMPED AWAY OVER 300MM.

TYPICAL INSTALLATION

CONCRETE

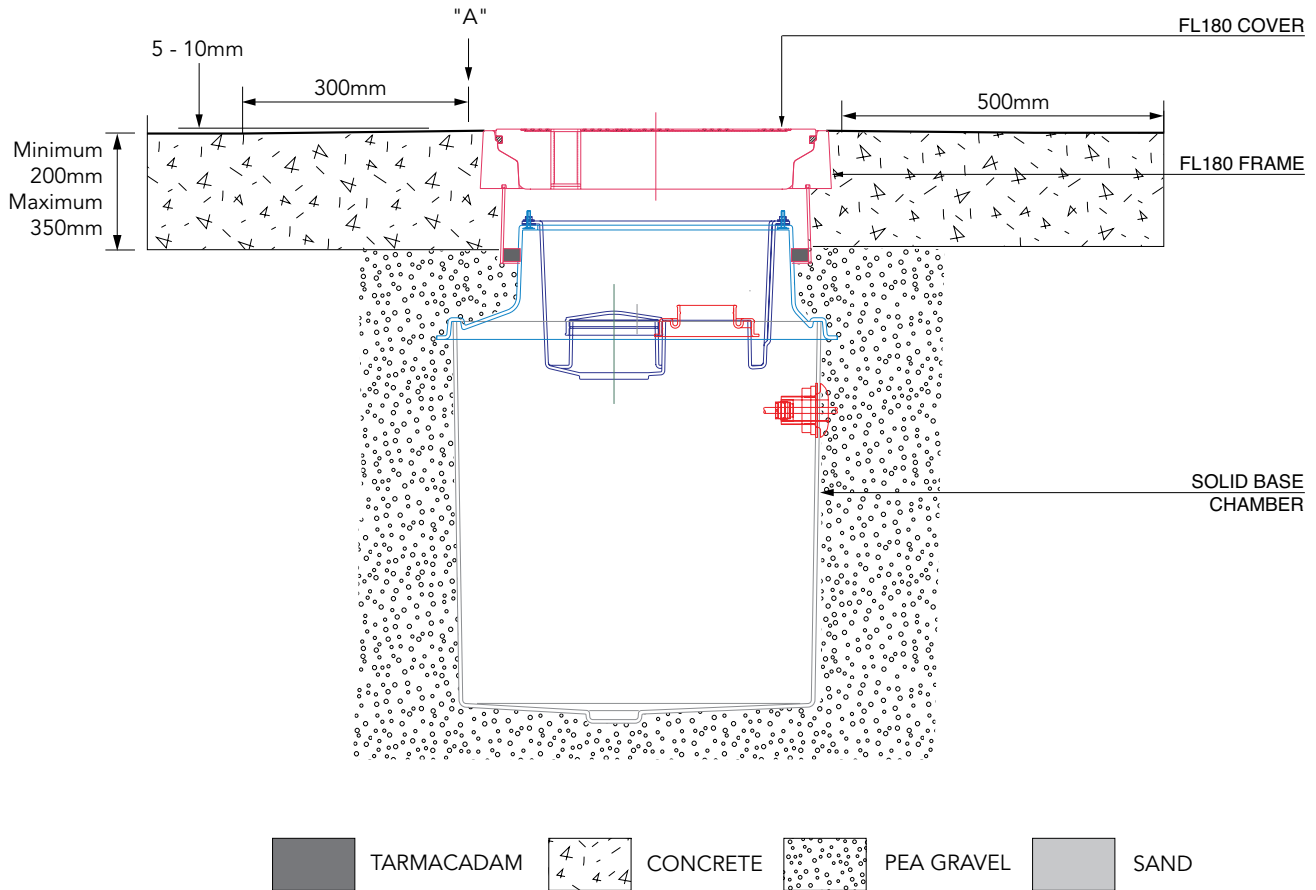

ALTERNATIVE INSTALLATION ADVICE

TARMACADAM

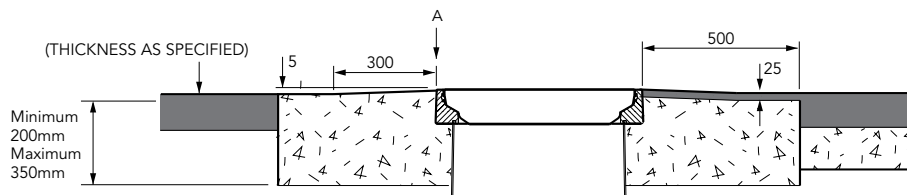

SETTS

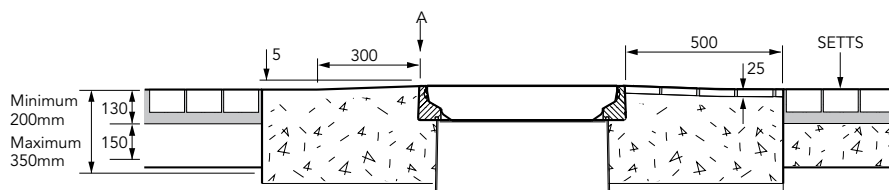

Secondary contained remote fill sump. 583mm dia. x 635mm deep solid base sump with a sealed secondary spill container and integrated drainback system. 450mm dia flat sealed cover and frame. Includes PSB-90-PS 90mm dia. spill tray fill riser sealkit and grounding cable sealkit.

For reference purposes only. This drawing is not a specification. Order against product code only. To enable continuous improvement of our products, the designs and specifications are subject to change without notice.

